

Profile 45x45 LR B-Type slot 10

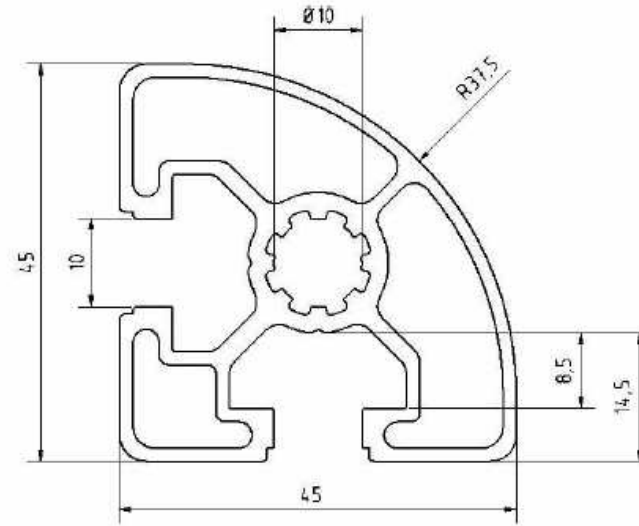
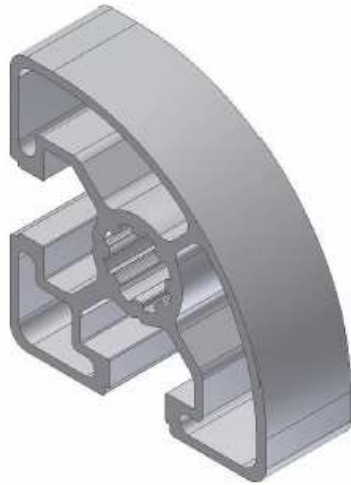

Profile 45x45 LR B-Type slot 10

Slot		10	mm
Mass	m	1,3	Kg/m
Moment of Inertia	Ix	8,5	cm ⁴
	Iy	8,5	cm ⁴
Section modulus	Wx	3,4	cm ³
	Wy	3,4	cm ³
Surface	A	4,9	cm ²