

Profile 8 R40/80-45° I-Type slot 8

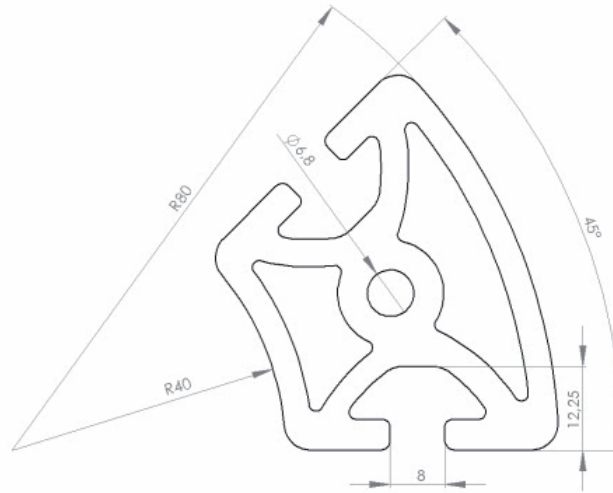

Profile 8 R40/80-45° I-Type slot 8

Slot		8	mm
Mass	m	2,77	Kg/m
Moment of Inertia	Ix	22,42	cm ⁴
	Iy	16,68	cm ⁴
Section modulus	Wx	7,08	cm ³
	Wy	6,38	cm ³
Surface	A	10,27	cm ²