

Profile 40x40 0N I-Type slot 8

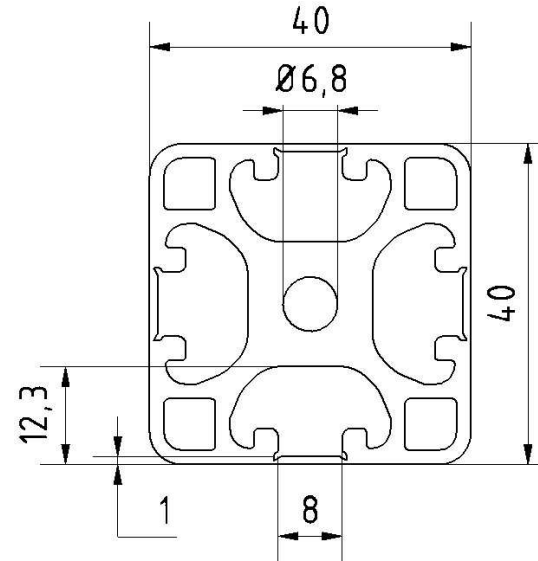
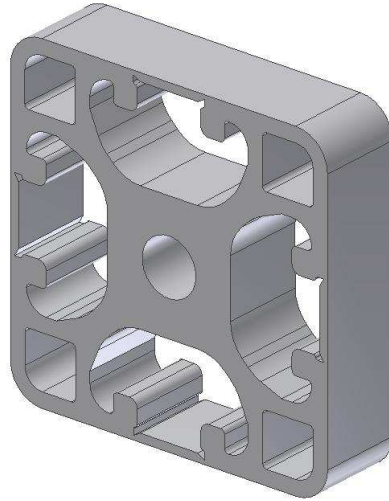

Profile 40x40 0N I-Type slot 8

Slot		8	mm
Mass	m	1,86	Kg/m
Moment of Inertia	Ix	9,79	cm ⁴
	Iy	9,79	cm ⁴
Section modulus	Wx	4,89	cm ³
	Wy	4,89	cm ³
Surface	A	6,86	cm ²