

Profile 30x30 B-Type slot 8

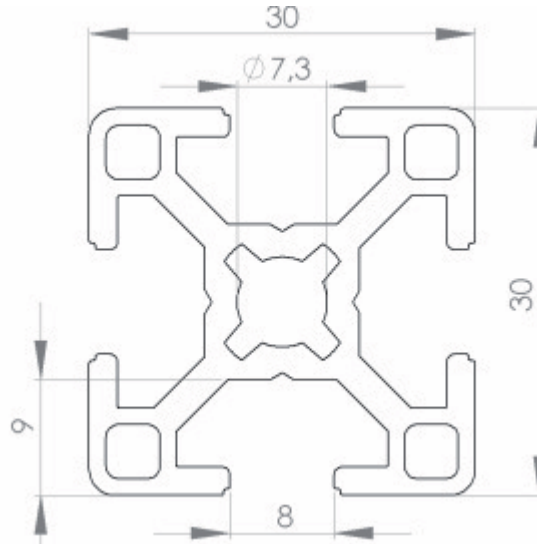
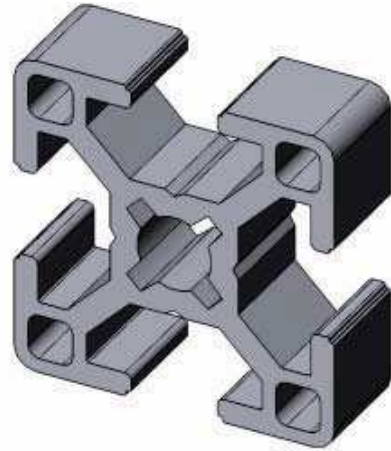

Profile 30x30 B-Type slot 8

Slot		8	mm
Mass	m	0,80	Kg/m
Moment of Inertia	Ix	2,70	cm ⁴
	Iy	2,70	cm ⁴
Section modulus	Wx	1,80	cm ³
	Wy	1,80	cm ³
Surface	A	2,90	cm ²