

Profile 40x40 I-Type slot 5

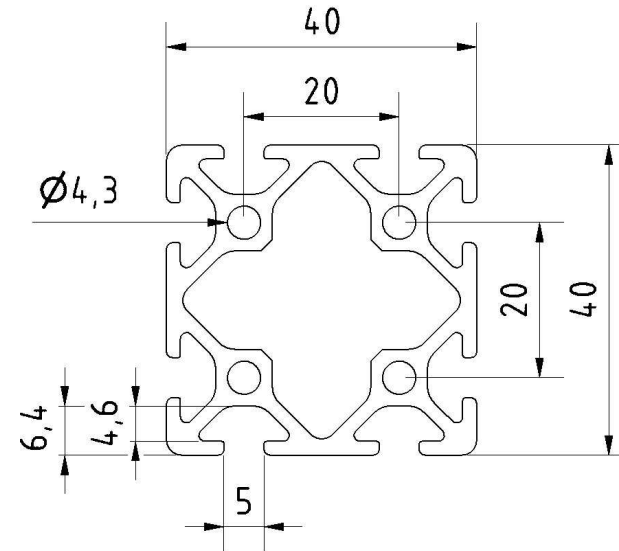
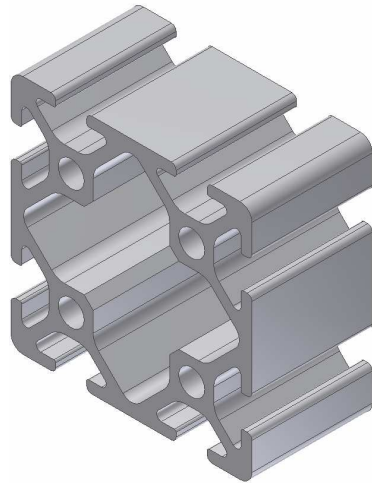

Profile 40x40 I-Type slot 5

Slot		5	mm
Mass	m	1,38	Kg/m
Moment of Inertia	Ix	9,24	cm ⁴
	Iy	9,24	cm ⁴
Section modulus	Wx	4,62	cm ³
	Wy	4,62	cm ³
Surface	A	5,10	cm ²