

# Profile 20x10 I-Type slot 5

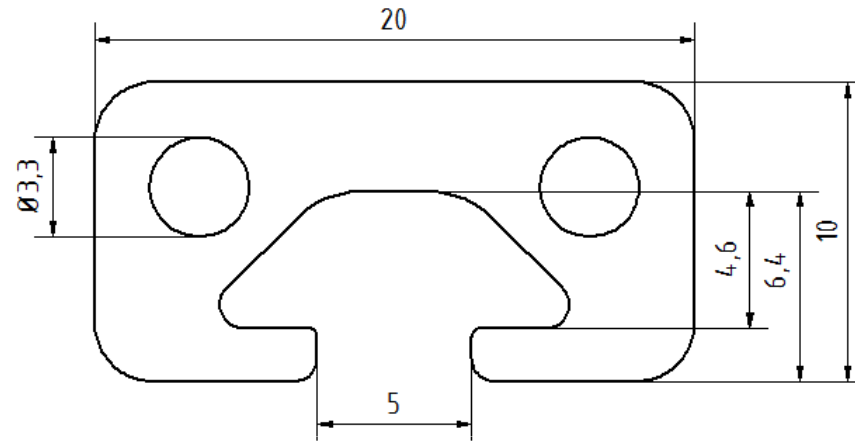
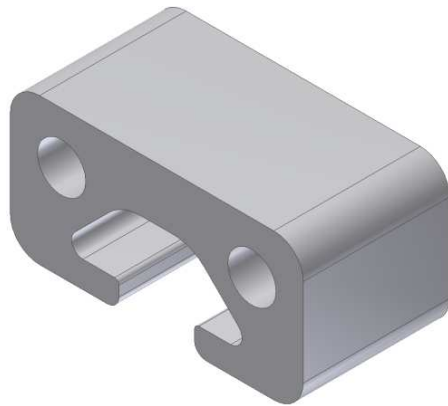

## Profile 20x10 I-Type slot 5

Slot		5	mm
Mass	m	0,35	Kg/m
Moment of Inertia	Ix	0,12	cm <sup>4</sup>
	Iy	0,53	cm <sup>4</sup>
Section modulus	Wx	0,22	cm <sup>3</sup>
	Wy	0,53	cm <sup>3</sup>
Surface	A	1,29	cm <sup>2</sup>