

Profile 20x60 B-Type slot 6

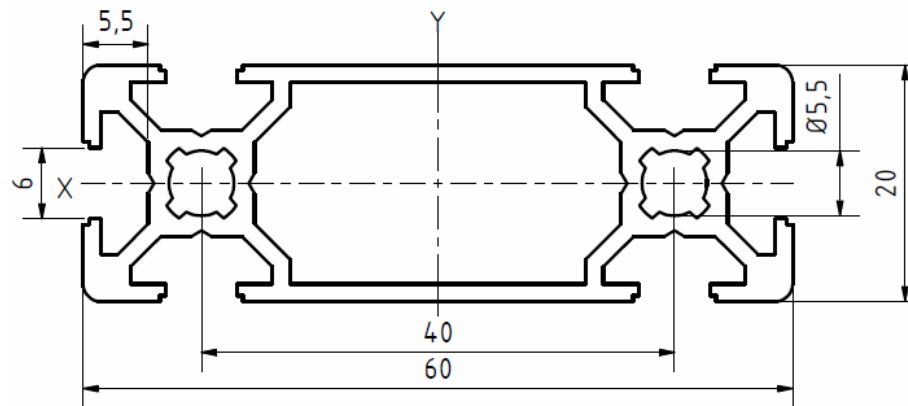
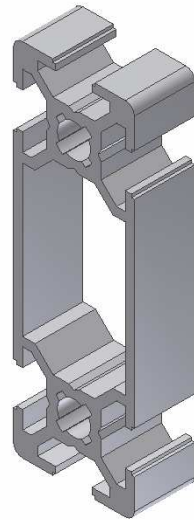

Profile 20x60 B-Type slot 6

Slot		6	mm
Mass	m	0,9	Kg/m
Moment of Inertia	Ix	1,7	cm ⁴
	Iy	14,2	cm ⁴
Section modulus	Wx	1,7	cm ³
	Wy	4,7	cm ³
Surface	A	3,5	cm ²